

**CREATE YOUR OWN
MONSTER**
FRANKENSTEIN
Made with Pride **TRIKES** Pleasanton, KS, U.S.A.

Installation Guide

Yamaha

40" Sport Trike Kit

All Years



INCLUDED IN YOUR TRIKE KIT:

COMPONENTS

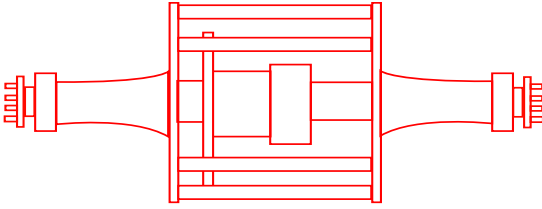

Frankenstein Trikes Rear End

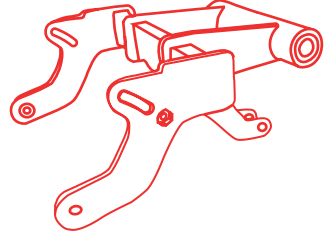

Swing Arm

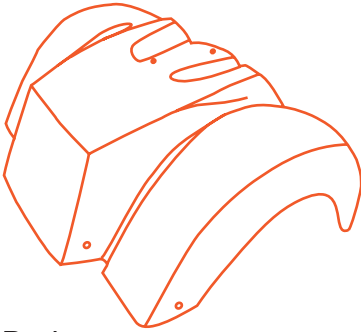

Body

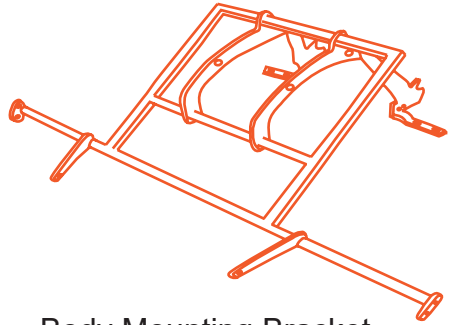

Body Mounting Bracket

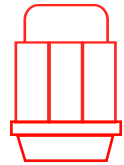
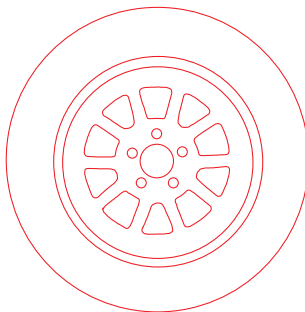
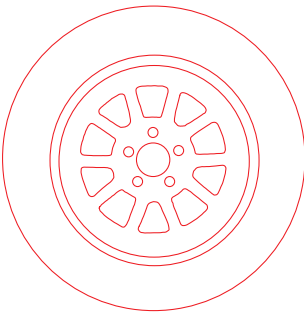

10 lug nuts

2 lon 15" X 8" wheels style 171-5865-P

1 2 Center caps and 2 General Altimax 215/60R15 tires

HARDWARE

PULLEY MOUNTING

pre-installed onto the rear end.

5 pcs. - 7/16" -14 x 1 1/2" Grd. 8 (Gold) Bolt

5 pcs. - 7/16" Lock Washer

BODY MOUNTING

8 - 1" dia. Rubber Washers

11 - 1 1/2" dia. Rubber Washers

8 - 7/16" Flat Washers

8 - 10mm x 1.5 x 30 Allen Bolts

8 - 10mm x 1.5 Nylock Nut

2 - 3/16" Rivets Large Head *Pre-installed*

NOTE! Additional hardware used to mount fender brackets to the rear end are pre-installed onto the rear end.

FRAME WORK

8 - 8mm x 1.25 x 25mm Hex Bolts

8 - 8mm x 1.25 Nylock Nuts

2 - 10mm x 1.25 x 30mm Hex Bolts

2 - 10mm x 1.25 Nylock Nuts

PASSENGER SEAT BRACKET

2 - 6mm x 1.0 X 15mm Hex Bolts

2 - 6mm Flat Washers

WHEEL MOUNTING

10 - Lug Nuts



LOCTITE is included with every kit and must be used where instructed in this manual.

STAGE 1. Motorcycle Preparation:



Always refer to your Yamaha owners manual before performing any work on your bike.

1. Secure front wheel so motorcycle won't tip, set jack under the motorcycle and raise the jack to take the weight off of the rear wheel.



mufflers will be too long for your Frankenstein Trike Kit.

2. Remove mufflers.

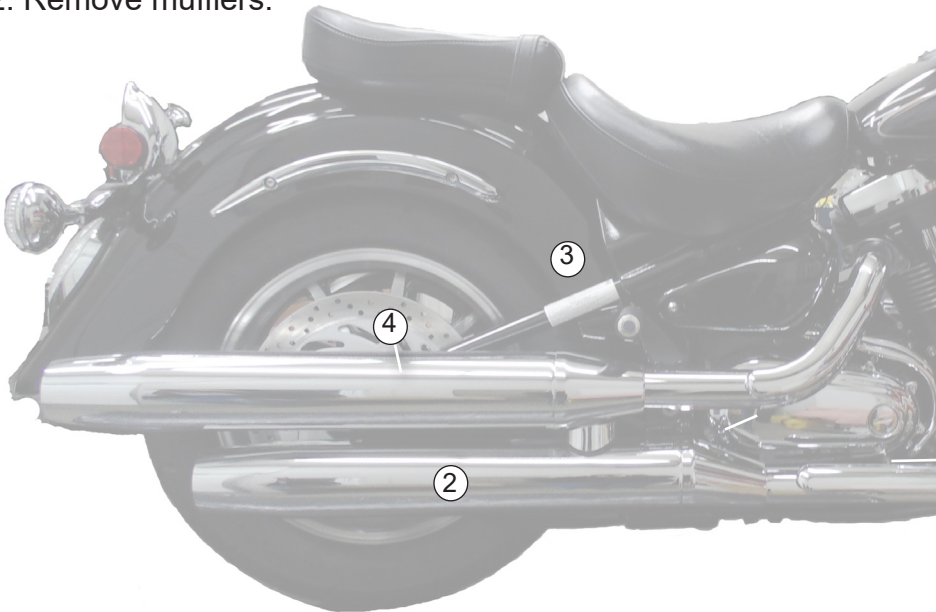

3. Remove banjo bolt from caliper



Once the brake line is unhooked from caliper, make sure to hang line upright so no fluid leaks out and no air gets trapped in the brake line.



4. Remove axle from wheel and swing arm. Move wheel forward to be able to slide the belt off of the pulley.
5. Slide the belt off of the pulley.
6. Remove rear wheel, you may need to raise the jack to get the **3** wheel out from under the bike.



Shown - Yamaha your bike may vary depending on the year



7. Remove shock bolt from Swing Arm.
8. Remove pivot shaft. Remove swing arm.

TIP Now would be a good time to check the condition of your pulley and belt.

STAGE 2. Rear End Preparation/Installation:

★ 38" and longer rear ends are shipped with one or both axles not installed in the rear end. To install axles, remove the axle retainer plate (see diagram 13 pg. 7) and insert axle. Reinstall bolts, loctite and torque to 31 ft. lbs.

1. With swing arm and rear wheel removed, have a friend help set a wheel and tire on the brake side of the rear end. Install with lug nuts.

TIP Install center cap into wheel before mounting.

2. Set the rear end on the wheel that was previously installed. Remove the five bolts to the spokes, Remove axle, axle housing and star plate as a unit.



Do not remove green tape, it will be used as a reference point in the following instructions.



3. If your pulley or sprocket has a center hole with a diameter of approximately 1.980" (50.292mm) then your pulley or sprocket will need to be machined. Install tool as shown using supplied bolts. Place back side of tool onto lathe chuck. Use boring tool to expand the diameter of the center hole. Measure frequently while boring until the diameter of the center hole is 2.212" (56.185mm).

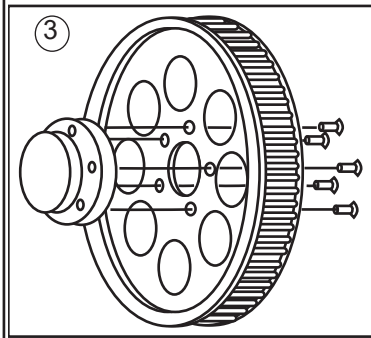
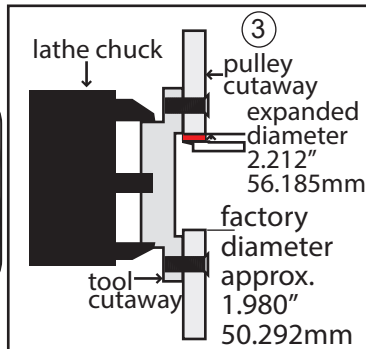
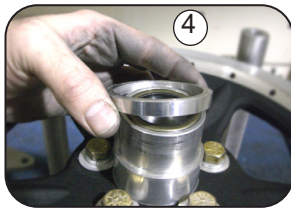

4. Install Pulley. Install 7/16" pulley bolts with lock washers provided apply **red loctite** and torque the pulley bolts. Have friend help hold the center section of the rear end with a screw driver through a hole in the rotor and through one of the holes in the star plate.
5. Torque the pulley bolts to 65 ft. lbs. Insert spacer

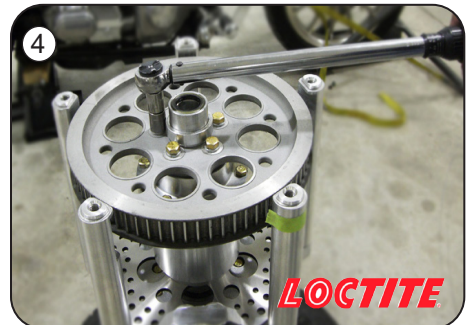

5. Install modified swing arm. Install pivot shaft.

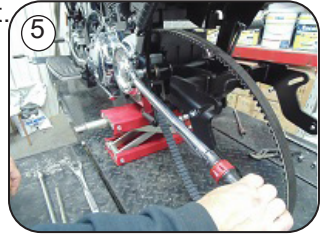

6. Slide the rear end under the bike. Lower the jack and set belt on pulley. (This is a little tricky but have patience) You may need to loosen the spokes on the opposite side of rear end to accommodate the belt installation. You may have to work around each spoke spreading them then inserting belt while lifting the axle.



7. Slide drive side star plate onto rear end differential housing, align the star plate with the spoke that was marked with the green tape. Start all 1/2" allen bolts on star plate into spokes, tighten evenly. **DO NOT FORCE BOLTS IN**

8. Remove the 1/2" allens one at a time apply blue loctite and reinstall torque 60 ft. lbs. Both Sides.



9. Install lower swing arm mounting bolts both side leave loose. Install upper swing arm mounting bolts, make sure to put the washer between the swing arm and the star plate on both sides leave loose. Refer to diagram for placement of washers and spacers.

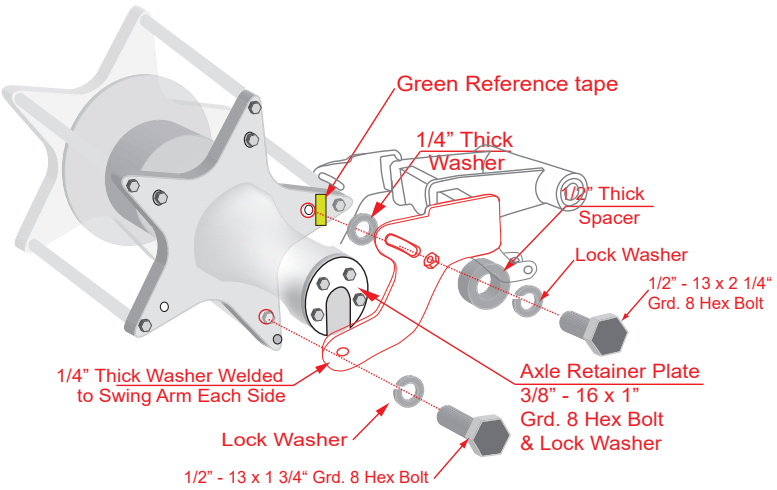
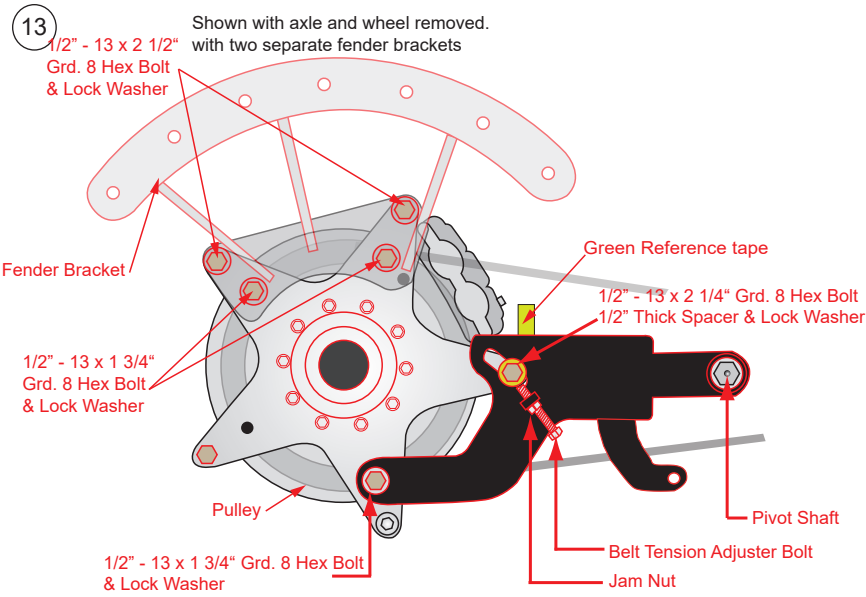

10. Install brake line to rear caliper and bleed.

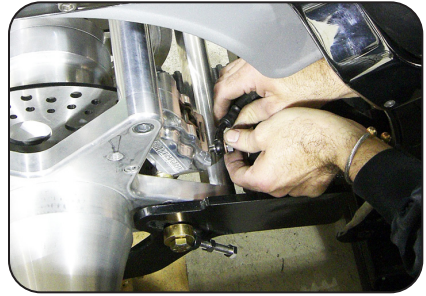
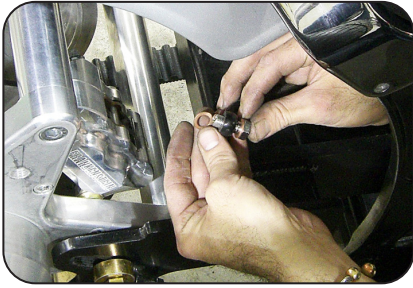

⚠ *The trike must be sitting on the ground on its suspension to adjust the belt. Shown without wheel and on blocks for photography.*

11. Adjust belt tension to factory specs.

12. Tighten jam nut on adjuster bolts.

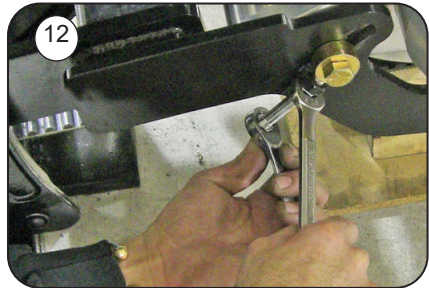
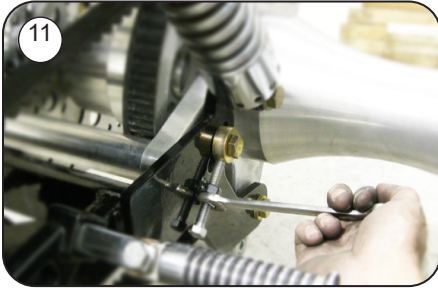

13. Remove front and back seats.

Then remove the fender mount bolts. Remove fender. Remove the passenger seat bracket from fender. You will need to remove the small tool bag bracket.



Tool bag bracket

14. Once rear fender is removed from bike. Remove trim pieces on each side.(if your bike has this trim)You can now remove the inner support bracket and wiring harness. You will need to extend the wiring harness after you have chosen and installed the tail lights of you choice.



15. Replace the inner support bracket onto bike. Place body mounting bracket over the inner support bracket and hold in place with 8mm bolts. Do not loctite bolts at this time.



16. Place a straight edge across the front seat brackets. From rear of trike look toward the front of the bike through the body frame making sure it is level. If there is more open space on one side than the other, then loosen bolts to adjust frame and retighten.



Seat bracket

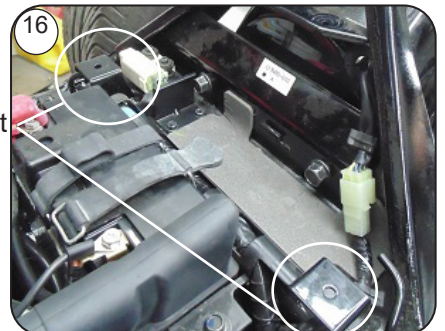

17. Remove passeger foot peg brackets. Place large body frame brace in position. (they are marked left or right). Holding large body frame brace and the foot peg replace bolts.(repeat on opposite side) Use masking tape on outside of brace to protect powder coating.



18. Place front body mounts on inside of bottom of the large body frame brace with 8 mm hex head bolts and nylock nuts. *Bolt head must be on outside. Do not tighten down tight. These are also stamped left and right.

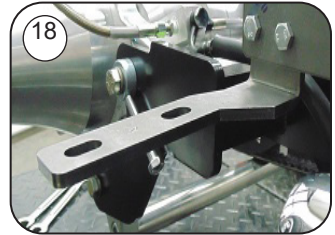

19. Secure large rubber washers to body mount holes. Place body on frame secure body to frame with bolts. Make sure rubber washers are between body and frame. Check for squareness (level). Remove body



20. Drill front frame hole. *Do not drill before verifying squareness/level of frame and body. Use 13/32" drill bit to drill hole. Use 10 mm hex bolts and lock nuts and tighten.



21. Replace body on frame-secure body to frame with chrome button head allen bolts and rubber washers like diagram below. The front body mounts in picture 18 must be tightened to body first. Replace the passenger seat bracket using 2 longer 6 mm hex head bolts in rear holes, use stock bolt in front hole. Install front seat.

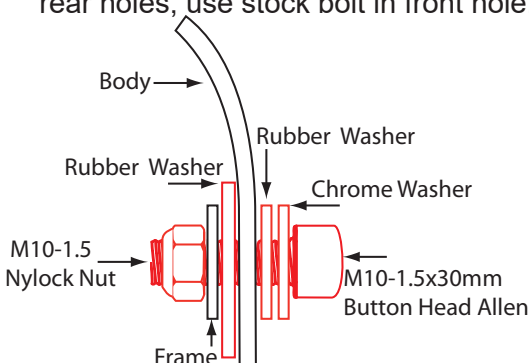

Our Trike rear ends are made from all 6061 T6 billet aluminum, except for our Light Sport Std. Trike rear end, which has 3/8" thick steel star plates, powder coated silver, instead of 1" thick billet aluminum star plates that we use on all our other Trike rear ends.

All of our rear ends have a Dana 30 differential, packed with Moly EP grease. 9" Ford street/strip axles with a bolt pattern of 5 studs on 4 1/2" bolt circle, wheel studs are 1/2" -20. HHI/Frankenstein 4 piston billet caliper, 11 1/2" stainless steel brake rotor, or optional outboard Brakes with two HHI/Frankenstein 4 piston billet calipers and two 11" stainless steel brake rotors. We only use top quality new parts in our manufacturing of "Frankenstein Trikes" rear ends.

Replacement Parts

Differential seal: National oil seal # 481213 \$12.00 each

Differential Bearing: # 62102RS \$24.00 each

Axle Bearing: BCA # RW207-CCRA \$65.00 each

Brake Pads: HHI-101-001 \$39.00 pair

prices subject to change



Note: Initially the brake and rotor need to be worn in before maximum braking can be achieved. Please use caution.